

Embedded Solutions



CFast 1.0 Cards

Industrial Temp CFX520I Card

Wide Temperature

Transcend's CFX520I CFast card integrates a rapid and robust SATA interface into a CF card form factor, offering improved performance and convenience for POS and embedded systems. Featuring enhanced speed and robust portability, CFast cards are designed to perform like SSDs, and as such are extremely capable when used as bootable drives.

Features

- RoHS compliant product
- CFast Specification Version 1.0 compliant
- Support S.M.A.R.T (Self-defined)
- Support Security Command
- Support Global Wear-Leveling, Static Data Refresh, Early Retirement, and Erase Count Monitor functions to extend product life
- Built-in ECC (Error Correction Code) functionality and wear-leveling algorithm ensure reliable data transfer
- Fully compatible with devices and OS that support the SATA 3.0Gb/s standard
- Non-volatile SLC Flash Memory for outstanding data retention
- SLC NAND Flash

Ordering Information

2GB	TS2GCFX520I
4GB	TS4GCFX520I

Specifications

Appearance	Dimensions (Max.)	42.8 mm x 36.4 mm x 3.3 mm (1.69" x 1.43" x 0.13")
	Form Factor	Compact flash card
Interface	Bus Interface	SATA II 3Gb/s
Storage	Flash Type	SLC NAND flash
	Capacity	2 GB/4 GB
Operating Environment	Operating Voltage	3.3V±5%
	Operating Temperature	-40°C (-40°F) ~ 85°C (185°F)
	Storage Temperature	-40°C (-40°F) ~ 85°C (185°F)
	Humidity	0% ~ 95%
	Shock	Acceleration: 490 m/s ² (standard holding time: 11 ms, semi-sine wave, velocity change: 3.44 m/s)
	Vibration (Operating)	3 G (peak-to-peak), 5 Hz ~ 800 Hz (frequency)
Power	Power Consumption (Max.)	0.50 watt(s)
Performance	Read Speed (Max.)	63 MB/s
	Write Speed (Max.)	28 MB/s
	Mean Time Between Failures (MTBF)	1,000,000 hour(s)
Warranty	Warranty	Three-year Limited Warranty
Note	• Speed may vary due to host hardware, software, usage, and storage capacity.	

Mechanical Dimensions

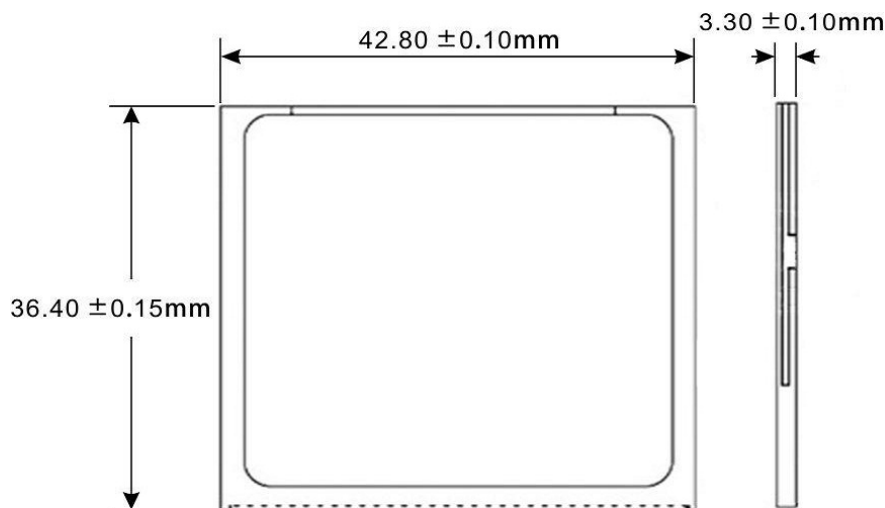

Product specifications are subject to change without notice. Pictures shown may differ from actual products. Total accessible capacity varies depending on operating environment. Due to the complexity and variety of industrial applications, Transcend cannot guarantee 100% compatibility with all platforms and under all scenarios. For special applications and environments, it is strongly suggested that you contact Transcend beforehand for clarification.



Please feel free to contact us with any special requests you might have.
Tel: +886-2-2792-8000 www.transcend-info.com